

Recessed down lights = Focus-S

Focus-S

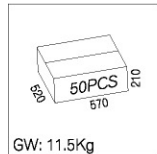

GW: 11.5Kg

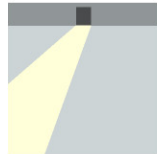
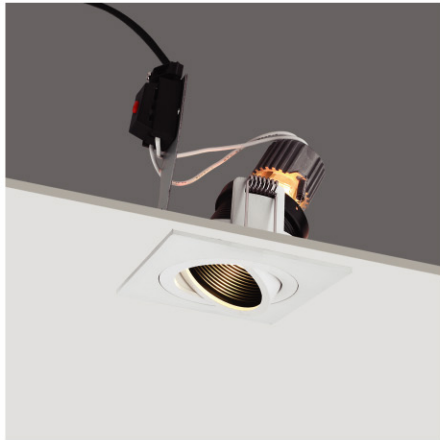
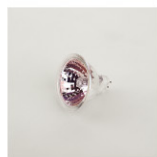
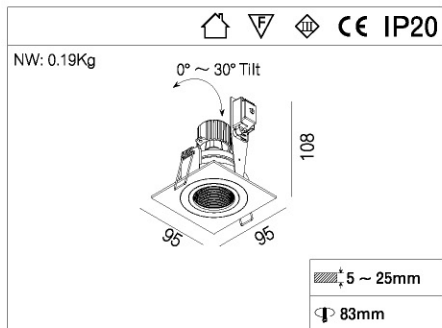

QR-CB51 (PHILIPS)

R4B0033 AW

Max.50W / excl. Electronic Transformer / GU5.3 / AC12V

R4B0033 AS

Max.50W / excl. Electronic Transformer / GU5.3 / AC12V

R4B0033 WH

Max.50W / excl. Electronic Transformer / GU5.3 / AC12V

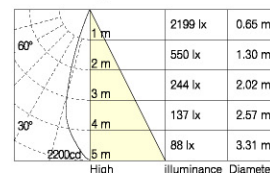
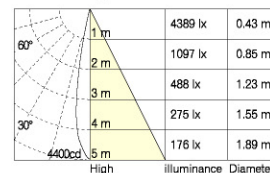
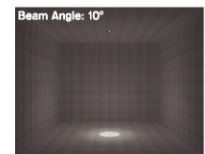
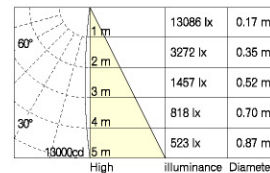

LED QR-CB51 (PHILIPS)

7W / 24° / 2700K / 1450cd / CRI: 80 / 40000hrs / GU5.3

7W / 36° / 2700K / 763cd / CRI: 80 / 40000hrs / GU5.3

7W / 60° / 2700K / 320cd / CRI: 80 / 40000hrs / GU5.3

7W / 24° / 3000K / 1550cd / CRI: 80 / 40000hrs / GU5.3

7W / 36° / 3000K / 810cd / CRI: 80 / 40000hrs / GU5.3

7W / 60° / 3000K / 341cd / CRI: 80 / 40000hrs / GU5.3

7W / 24° / 4000K / 1640cd / CRI: 80 / 40000hrs / GU5.3

7W / 36° / 4000K / 810cd / CRI: 80 / 40000hrs / GU5.3

7W / 60° / 4000K / 360cd / CRI: 80 / 40000hrs / GU5.3

